

LIMITED WARRANTY

BRYMEN warrants to the original product purchaser that each product it manufactures will be free from defects in material and workmanship under normal use and service within a period of one year from the date of purchase. BRYMEN's warranty does not apply to accessories, fuses, fusible resistors, spark gaps, batteries or any product which, in BRYMEN's opinion, has been misused, altered, neglected, or damaged by accident or abnormal conditions of operation or handling.

To obtain warranty service, contact your nearest BRYMEN authorized agent or send the product, with proof of purchase and description of the difficulty, postage and insurance prepaid, to BRYMEN TECHNOLOGY CORPORATION. BRYMEN assumes no risk for damage in transit. BRYMEN will, at its option, repair or replace the defective product free of charge. However, if BRYMEN determines that the failure was caused by misused, altered, neglected, or damaged by accident or abnormal conditions of operation or handling, you will be billed for the repair.

THIS WARRANTY IS EXCLUSIVE AND IS IN LIEU OF ALL OTHER WARRANTIES, EXPRESSED OR IMPLIED, INCLUDING BUT NOT LIMITED TO ANY IMPLIED WARRANTY OR MERCHANTABILITY OR FITNESS FOR A PARTICULAR PURPOSE OR USE. BRYMEN WILL NOT BE LIABLE FOR ANY SPECIAL, INDIRECT, INCIDENTAL OR CONSEQUENTIAL DAMAGES.



BRYMEN TECHNOLOGY CORPORATION

TEL:+886 2 2226 3396

FAX:+886 2 2225 0025

<http://www.brymen.com.tw>

PRINTED ON RECYCLABLE PAPER, PLEASE RECYCLE
COPYRIGHT © MCMXCIX BTC, ALL RIGHTS RESERVED
P/N: 7M1C-0042-0000 PRINTED IN TAIWAN

ESPAÑOL ELECTRONICS S.A.

Instrumentos de medición eléctricos y electrónicos

Av. Juan de Garay 809- PB- Dto B - 1153- Buenos Aires

☎ (54-11) 4 307- 4960

Fax (54-11) 4 300-6194

E.mail: eelectronics@arnet.com.ar

USER'S MANUAL

BM837RS

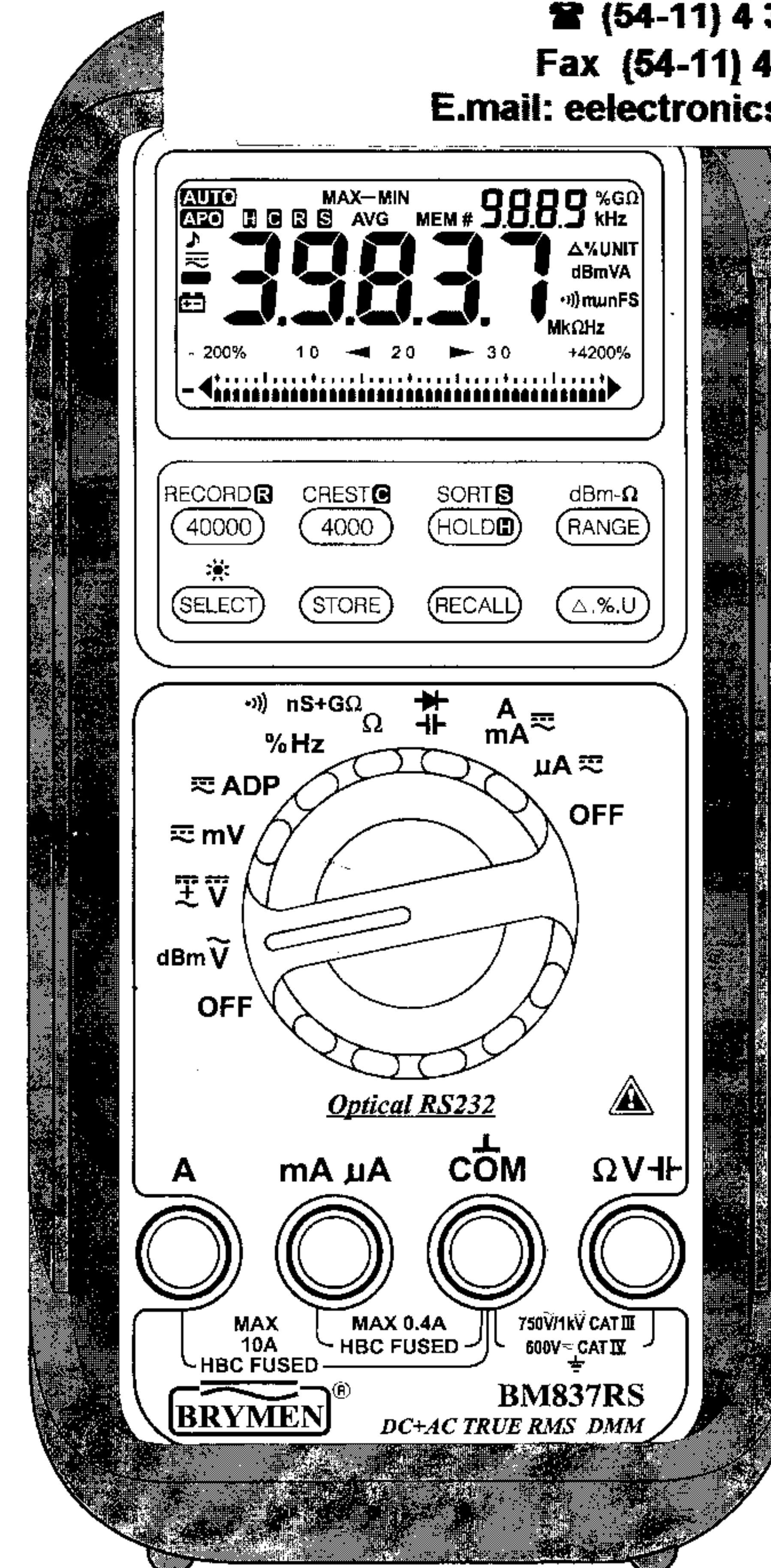

1) SAFETY

This manual contains information and warnings that must be followed for operating the meter safely and maintaining the meter in a safe operating condition. If the meter is used in a manner not specified by the manufacturer, the protection provided by the meter may be impaired. The meter is intended only for indoor use.

The meter meets the requirements for double insulation to IEC61010-1(1995), EN61010-1(1995), UL3111-1(6.1994), CSA C22.2 NO. 1010-1-92 to terminals:

V/R : Category IV 600V ac and dc, and Category III 1000V dc and 750V ac.

mA/ μ A : Category III 500V ac, and Category II 300V dc.

A : Category III 600V ac, and Category II 300V dc.

PER IEC61010 OVERVOLTAGE INSTALLATION CATEGORY

OVERVOLTAGE CATEGORY I

Equipment of OVERVOLTAGE CATEGORY I is equipment for connection to circuits in which measures are taken to limit the transient overvoltages to an appropriate low level. Note – Examples include protected electronic circuits.

OVERVOLTAGE CATEGORY II

Equipment of OVERVOLTAGE CATEGORY II is energy-consuming equipment to be supplied from the fixed installation.

Note – Examples include household, office, and laboratory appliances.

OVERVOLTAGE CATEGORY III

Equipment of OVERVOLTAGE CATEGORY III is equipment in fixed installations.

Note – Examples include switches in the fixed installation and some equipment for industrial use with permanent connection to the fixed installation.

OVERVOLTAGE CATEGORY IV

Equipment of OVERVOLTAGE CATEGORY IV is for use at the origin of the installation.

Note – Examples include electricity meters and primary over-current protection equipment.

TERMS IN THIS MANUAL

WARNING identifies conditions and actions that could result in serious injury or even death to the user.

CAUTION identifies conditions and actions that could cause damage or malfunction in the instrument.





WARNING

To reduce the risk of fire or electric shock, do not expose this product to rain or moisture. To avoid electrical shock hazard, observe the proper safety precautions when working with voltages above 60 VDC or 30 VAC rms. These voltage levels pose a potential shock hazard to the user. Do not touch test lead tips or the circuit being tested while power is applied to the circuit being measured. Keep your fingers behind the finger guards of the test leads during measurement. Inspect test leads, connectors, and probes for damaged insulation or exposed metal before using the instrument. If any defects are found, replace them immediately. Do not measure any circuit that draws more than the current rating of the protection fuse. Do not attempt a current measurement where the open circuit voltage is above the protection fuse voltage rating. Suspected open circuit voltage can be checked with voltage functions. Never attempt a voltage measurement with the test lead inserted into the μ A/mA or A input jack. Only replace the blown fuse with the proper rating as specified in this manual.

CAUTION

Disconnect the test leads from the test points before changing functions. Always set the instrument to the highest range and work downward for an unknown value if you are using manual ranging mode.

INTERNATIONAL ELECTRICAL SYMBOLS

	Caution ! Refer to the explanation in this Manual
	Caution ! Risk of electric shock
	Earth (Ground)
	Double Insulation or Reinforced insulation
	Fuse

2) ELECTROMAGNETIC COMPATIBILITY (EMC)

The instrument meets EN55022(1994/A1; 1995/Class B) and EN50082-1(1992)

3) PRODUCT DESCRIPTION

Panel Illustration

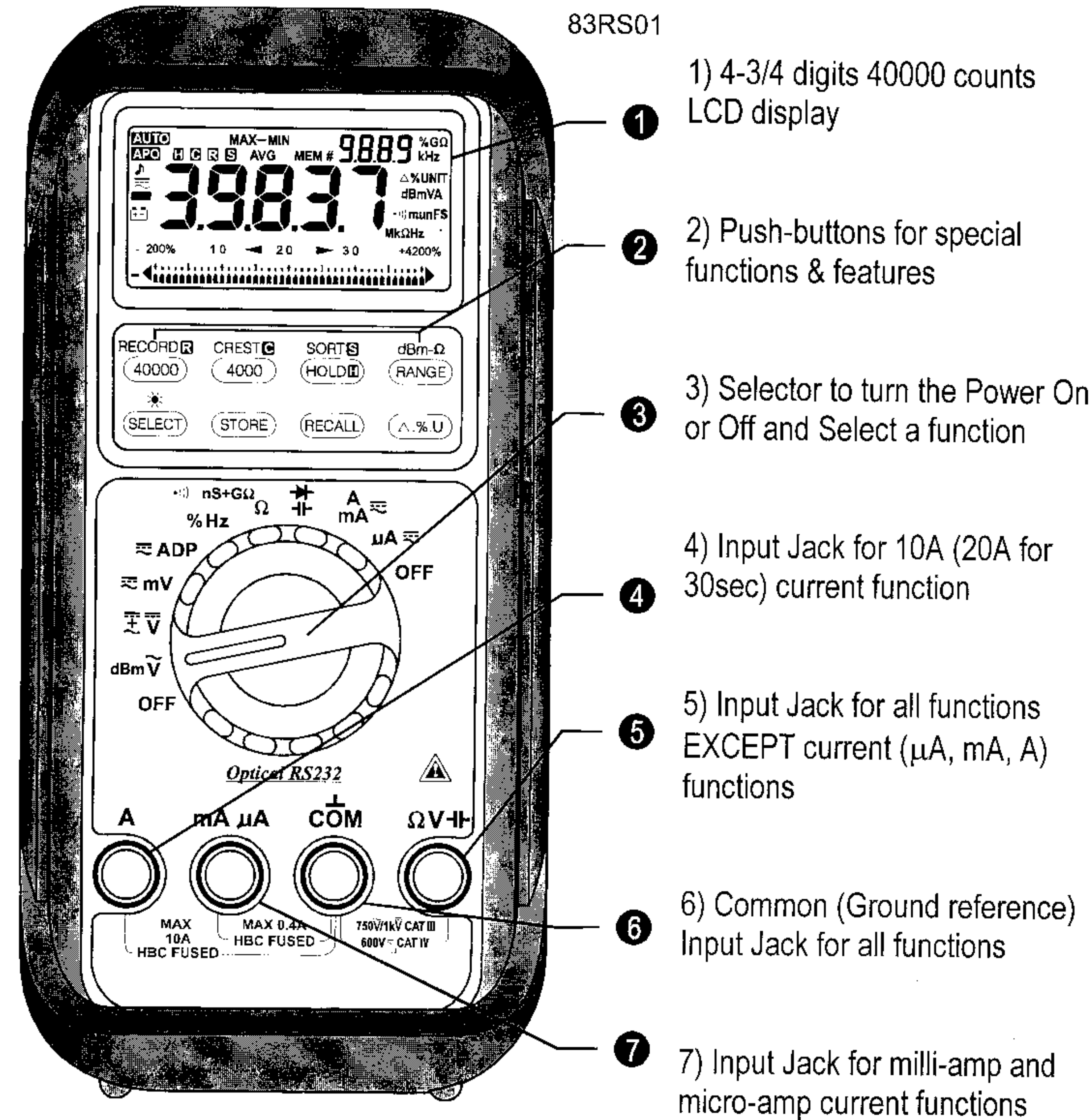

83RS01

- 1) 4-3/4 digits 40000 counts LCD display
- 2) Push-buttons for special functions & features
- 3) Selector to turn the Power On or Off and Select a function
- 4) Input Jack for 10A (20A for 30sec) current function
- 5) Input Jack for all functions EXCEPT current (μ A, mA, A) functions
- 6) Common (Ground reference) Input Jack for all functions
- 7) Input Jack for milli-amp and micro-amp current functions

Analog bar-graph

The analog bar graph provides a visual indication of measurement like a traditional analog meter needle. It is excellent in detecting faulty contacts, identifying potentiometer clicks, and indicating signal spikes during adjustments.

DC+AC True RMS

DC+AC True RMS is a term which identifies a DMM that responds accurately to the total effective RMS value regardless of the waveforms such as: square, sawtooth, triangle, pulse trains, spikes, as well as distorted waveforms with the presence of harmonics and DC components. Harmonics and DC components may cause :

- 1)Overheated transformers, generators and motors to burn out faster than normal
- 2)Circuit breakers to trip prematurely
- 3)Fuses to blow
- 4)Neutrals to overheat due to the triplen harmonics present on the neutral
- 5)Bus bars and electrical panels to vibrate

Crest Factor

Crest Factor is the ratio of the Crest (instantaneous peak) value to the True RMS value, and is commonly used to define the dynamic range of a True RMS DMM. A pure sinusoidal waveform has a Crest Factor of 1.4. A badly distorted sinusoidal waveform normally has a much higher Crest Factor.

NMRR (Normal Mode Rejection Ratio)

NMRR is the DMM's ability to reject unwanted AC noise effect which can cause inaccurate DC measurements. NMRR is typically specified in terms of dB (decibel). This product has a NMRR specification of >60 dB at 50 and 60Hz, which means a good ability to reject the effect of AC noise in DC measurements.

CMRR (Common Mode Rejection Ratio)

Common mode voltage is voltage present on both the COM and VOLTAGE input terminals of a DMM, with respect to ground. CMRR is the DMM's ability to reject common mode voltage effect which can cause digit rattle or offset in voltage measurements. This series has a CMRR specifications of >60 dB at DC to 60Hz in ACV function; and >120 dB at DC, 50 and 60Hz in DCV function. If neither NMRR nor CMRR specification is specified, a DMM's performance will be uncertain.

4) OPERATION

ACV, ACV + Hz, & dBm + Hz functions

Defaults at ACV. Press **SELECT** button momentarily to select ACV + Hz. Press **SELECT** button momentarily again to select dBm + Hz. Input sensitivity for Hz varies automatically with voltage range selected in ACV + Hz function. It is designed especially for measuring the frequency of high voltage noisy electrical signals.

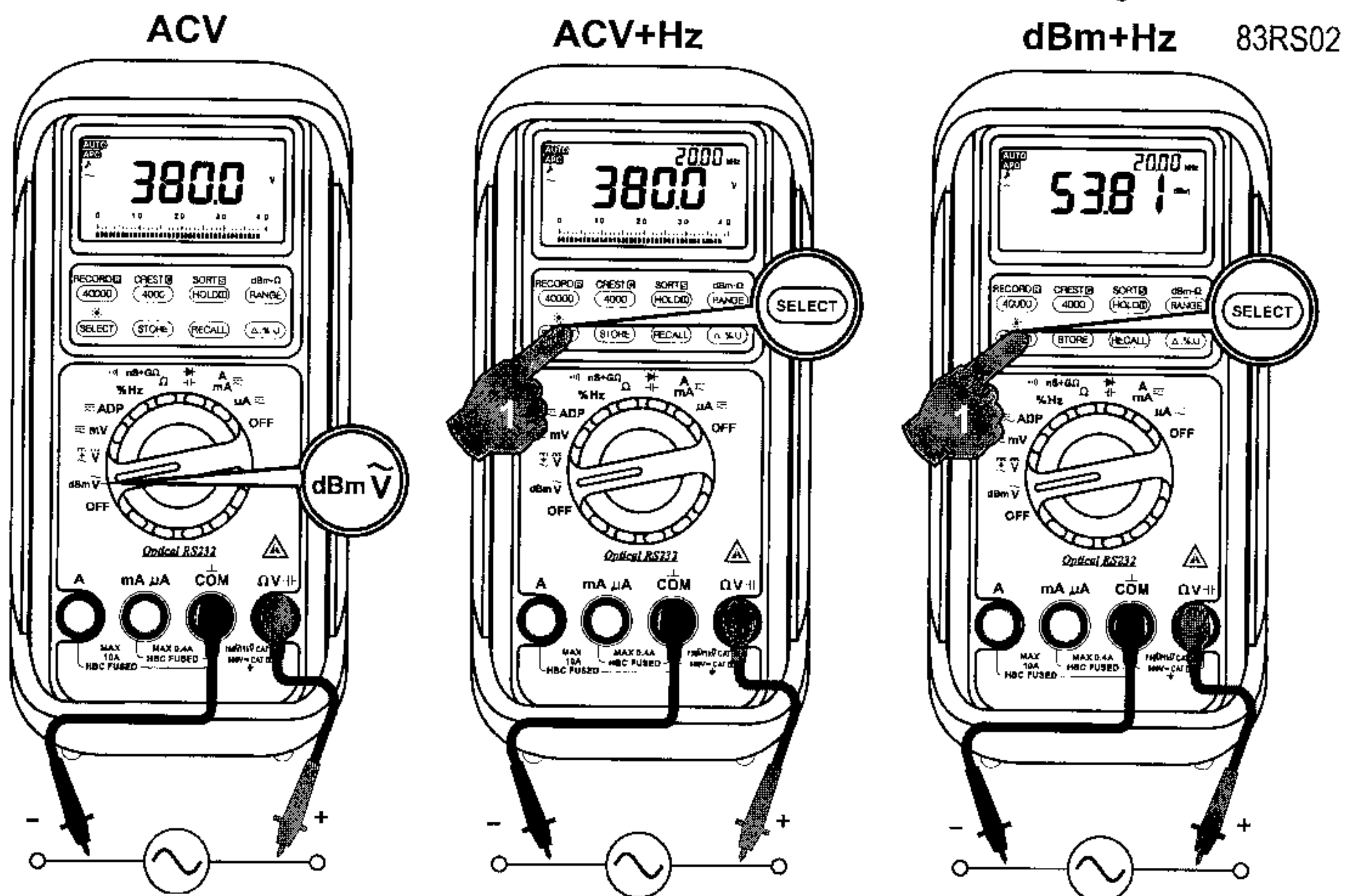

Note: Default Reference impedance 600Ω will be displayed for 2 seconds before displaying the dBm + Hz readings. Press **dBm-Ω (RANGE)** button momentarily to select different reference impedance from 4, 8, 16, 32, 50, 75, 93, 110, 125, 135, 150, 200, 250, 300, 500, 600, 800, 900, 1000, up to 1200Ω. Impedance values will again be displayed for 2 seconds before displaying the dBm + Hz readings.

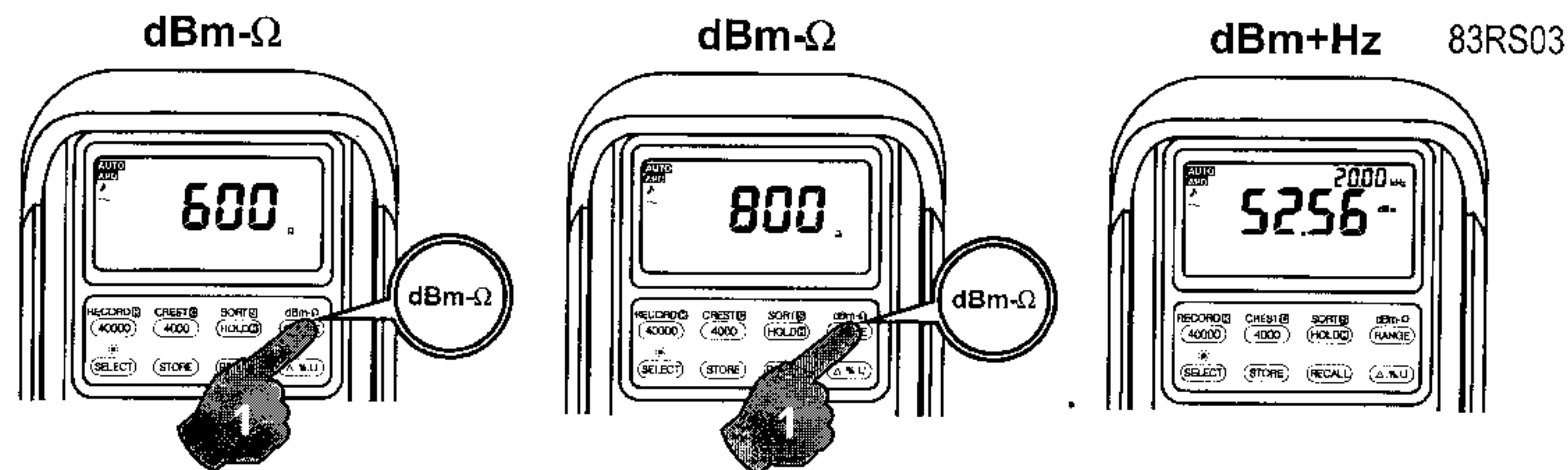

DCV, DC + AC V functions

Defaults at DC. Press **SELECT** button momentarily to select DC + AC. Analog bar-graph will be disabled in the DC + AC mode.

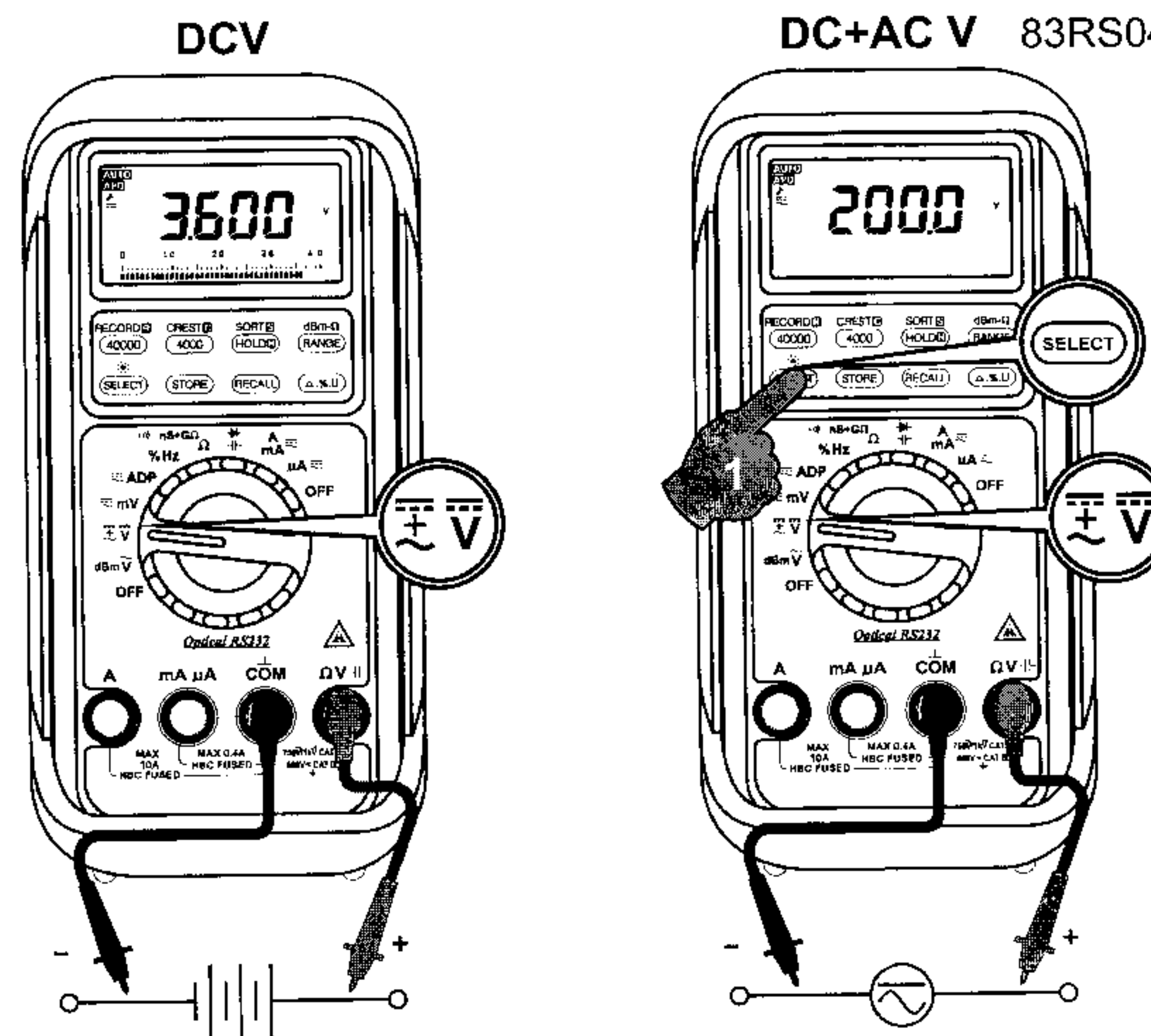

Hold

The hold function freezes the display for later view. Press the **HOLD** button momentarily to activate and to exit the hold function

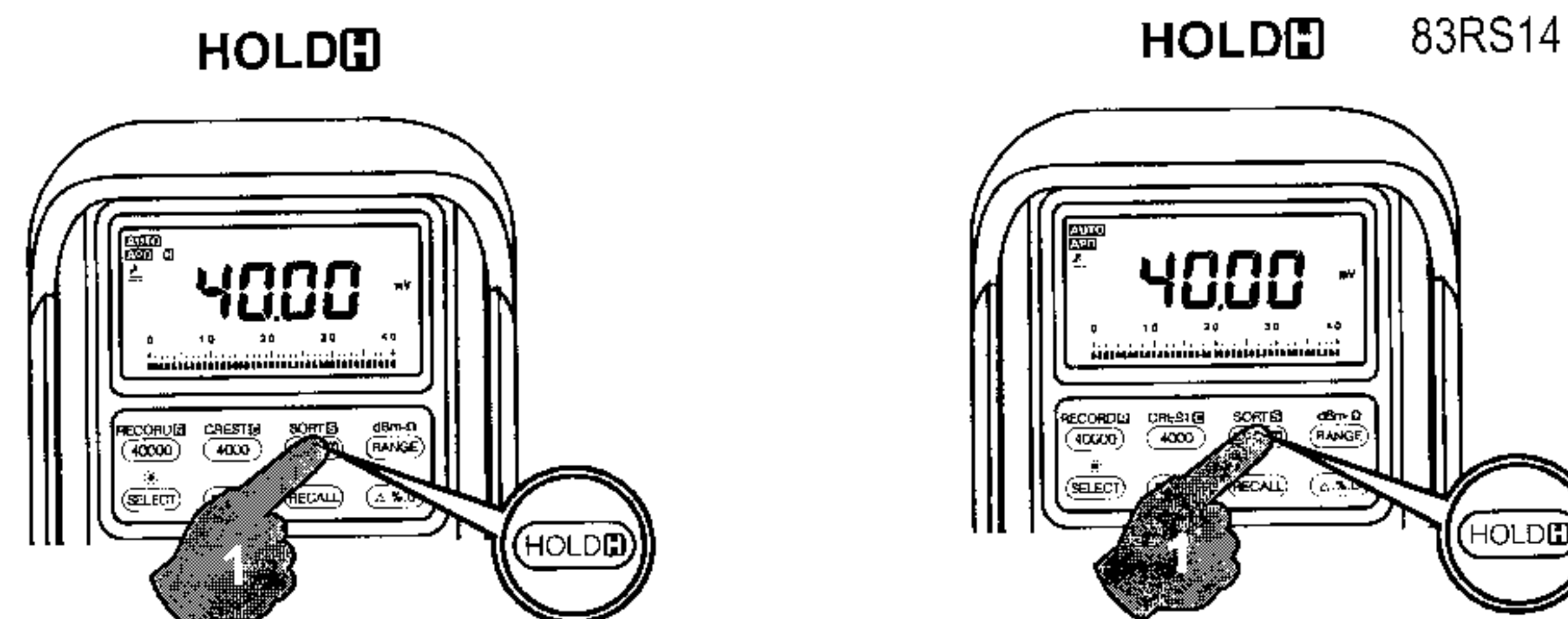

DC, AC, AC + Hz mV functions

Defaults at DC. Press **SELECT** button momentarily to select AC. Press **SELECT** button momentarily again to select AC + Hz.

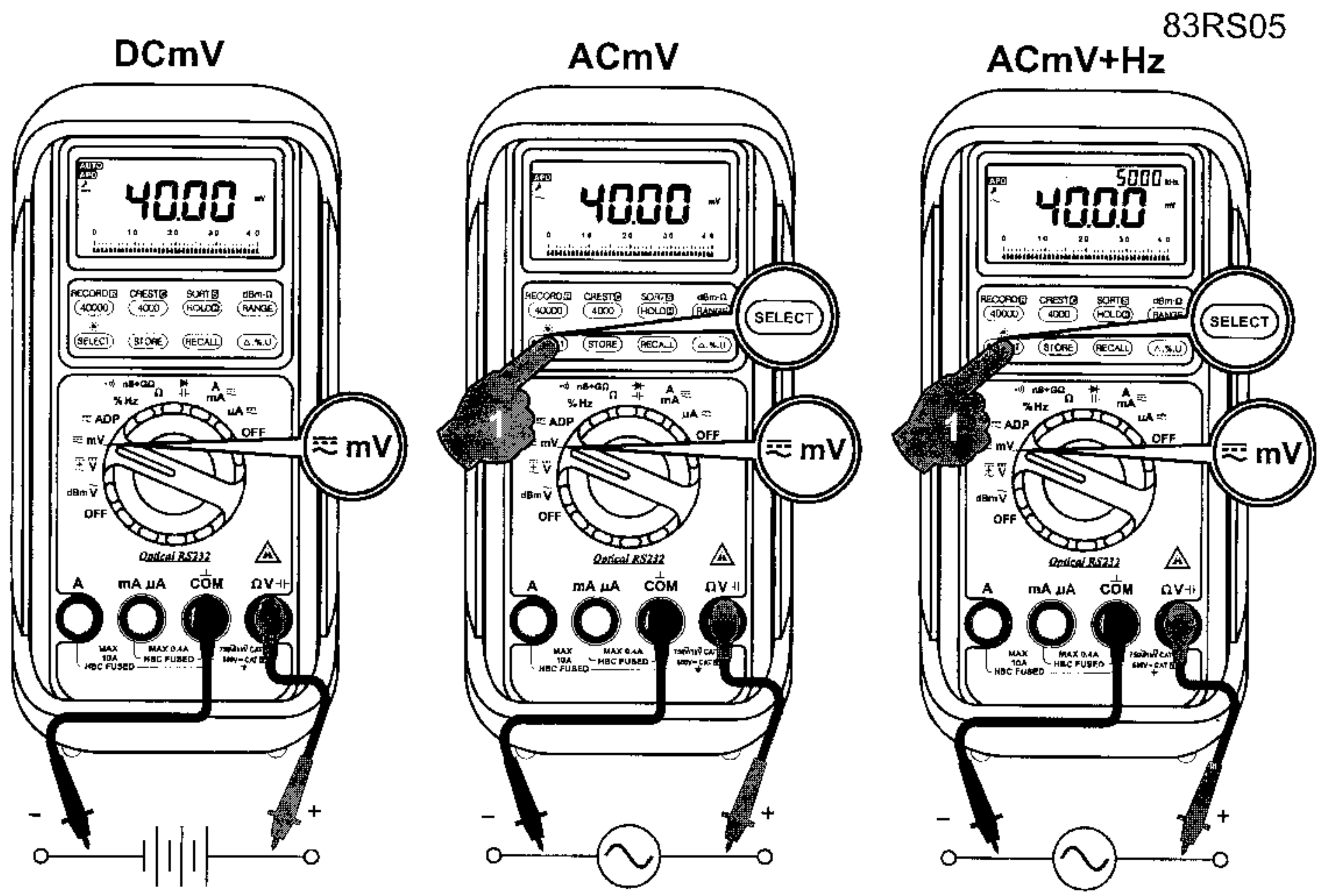

DC, AC, AC + Hz Adapter functions

The operation of Adapter function is similar to the mV function. Defaults at DC. Press **SELECT** button momentarily to select AC. Press **SELECT** button momentarily again to select AC + Hz. Adapter function is of extra high input impedance up to 1000MΩ, and there is no decimal point on the digital display. It can cope with most voltage output sensors/ transducers with the highest sensitivity and the least current drain.

Hz, % + Hz functions

Defaults at Hz. Press **SELECT** button momentarily to select % + Hz.

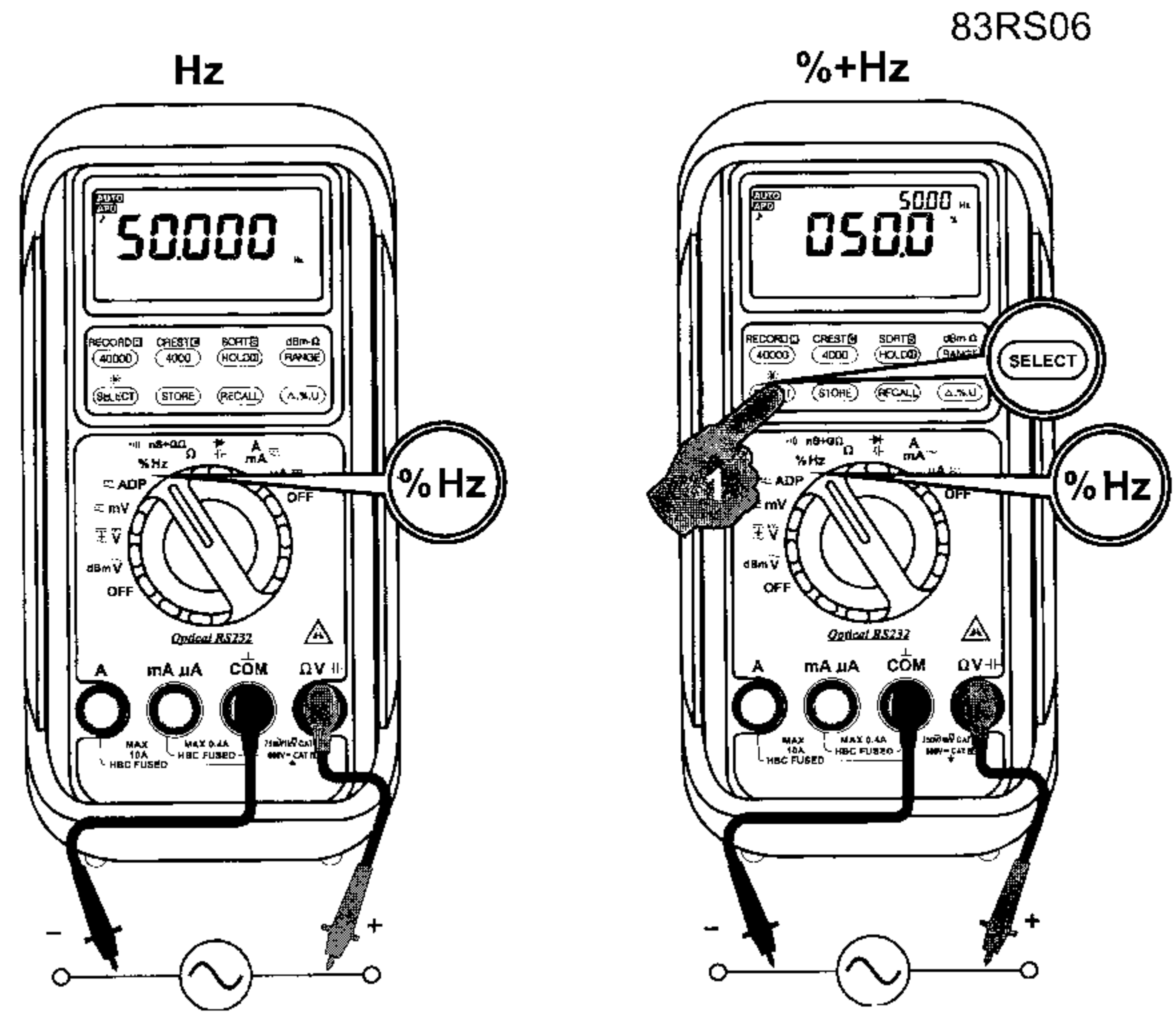

Note: Unlike the AC + Hz function, this high resolution Hz function is set at the highest input sensitivity to measure digital type electronic signals.

Backlighting display

Press the **SELECT** button for 1 second or more to turn on and off the display backlight function. The backlight will also be turned off automatically after 42 seconds to extend battery life.

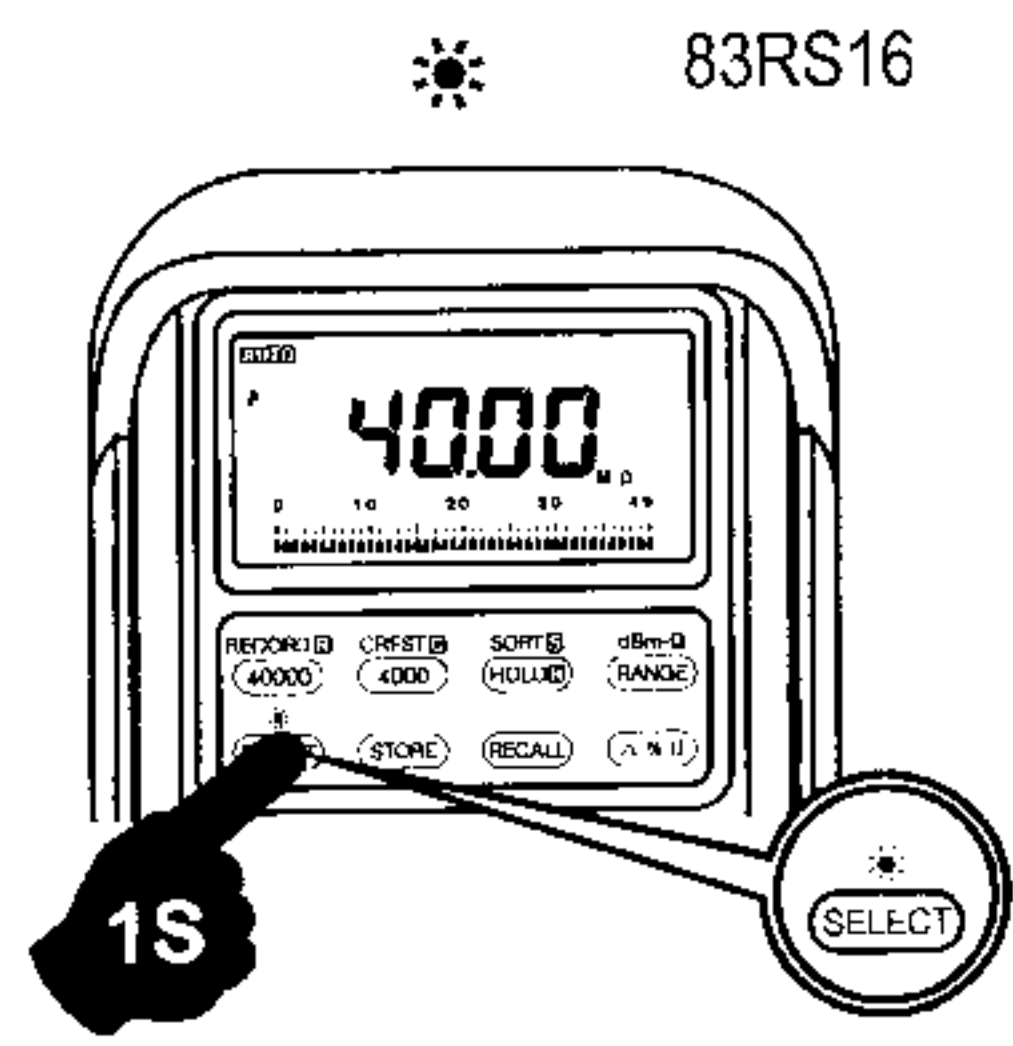

Ω Resistance, nS + GΩ Conductance, \rightarrow) Continuity functions

Default at Ω. Press **SELECT** button momentarily to select nS + GΩ Conductance for resistance measurement beyond 40MΩ. Press **SELECT** button momentarily again to select \rightarrow) Continuity function which is convenient for checking wiring connections and operation of switches. A continuous beep tone indicates a complete wire.

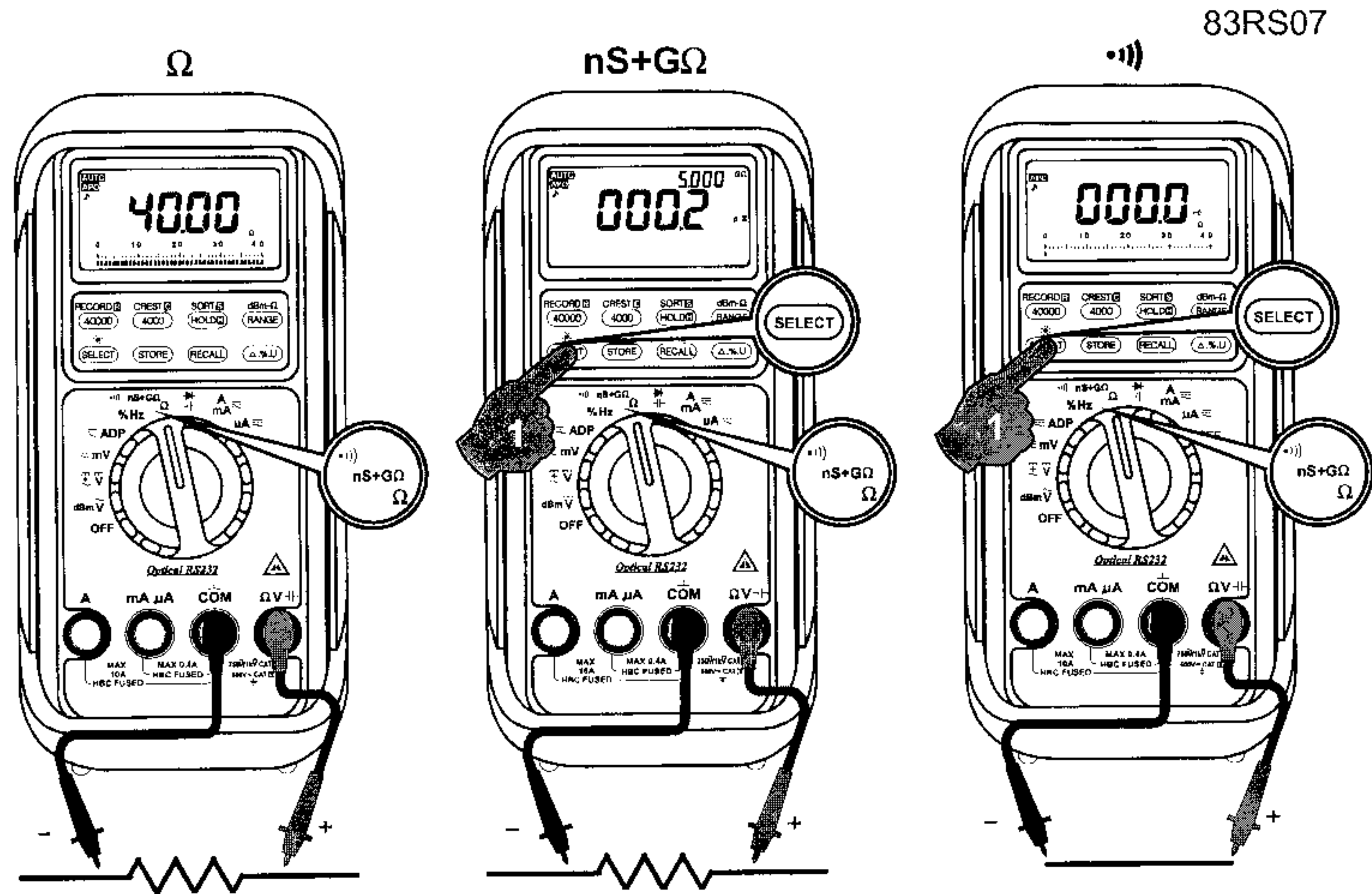

CAUTION

Using resistance and continuity function in a live circuit will produce false results and may damage the instrument. In many cases the suspected component must be disconnected from the circuit to obtain an accurate reading

⚡ Capacitance, \rightarrow) Diode test function

Default at ⚡. Press **SELECT** button momentarily to select \rightarrow) Diode test function.

CAUTION

Discharge capacitors before making any measurement. Large value capacitors should be discharged through an appropriate resistance load

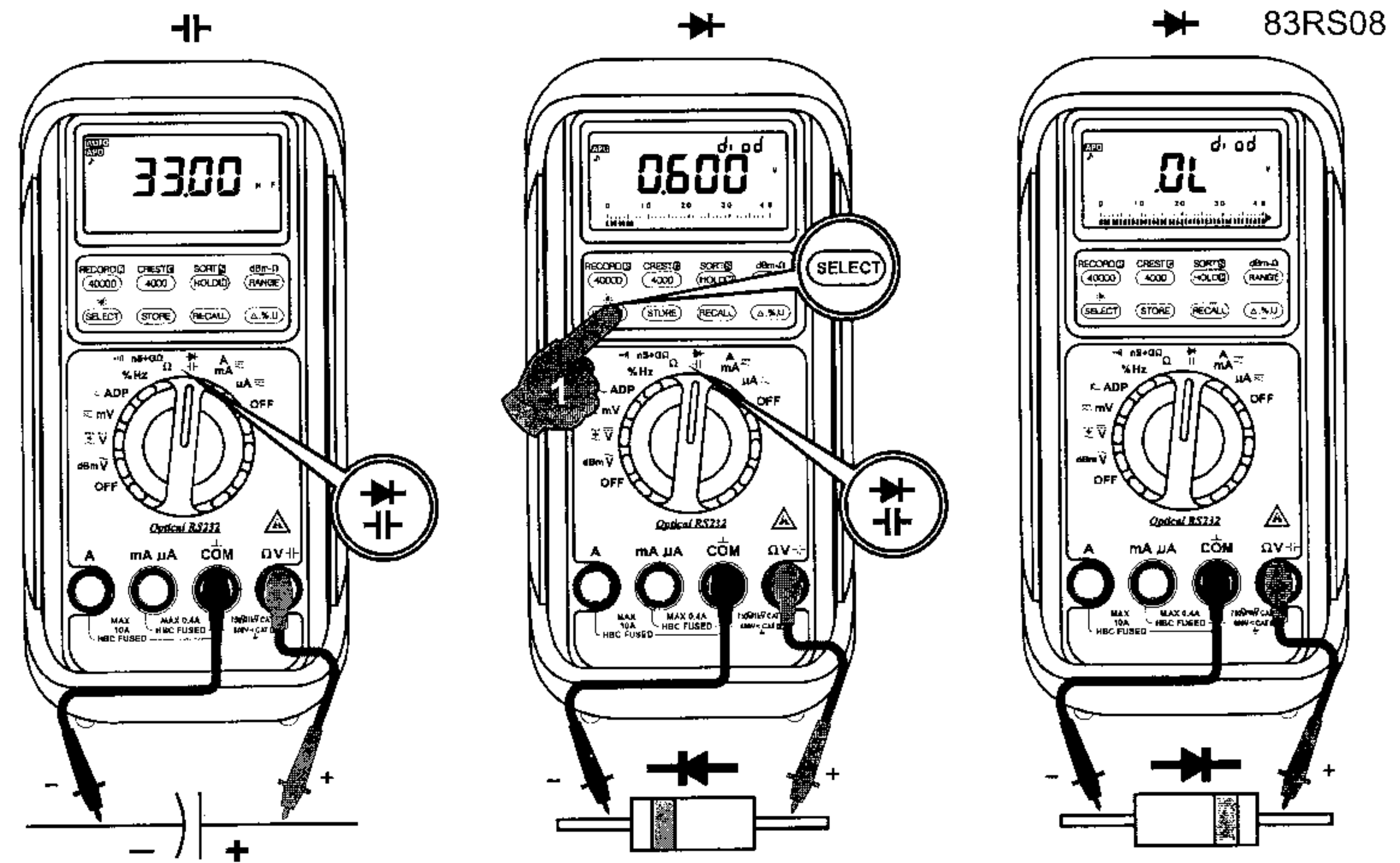

Note:

Normal forward voltage drop (forward biased) for a good silicon diode is between 0.400V to 0.900V. A reading higher than that indicates a leaky diode (defective). A zero reading indicates a shorted diode (defective). An OL indicates an open diode (defective). Reverse the test leads connections (reverse biased) across the diode. The digital display shows OL if the diode is good. Any other readings indicate the diode is resistive or shorted (defective).

µA, mA, and A Current functions

Default at DC. Press **SELECT** button momentarily to select AC. Press **SELECT** button momentarily again to select AC + Hz. A will be selected automatically when the correct input jack is plugged in.

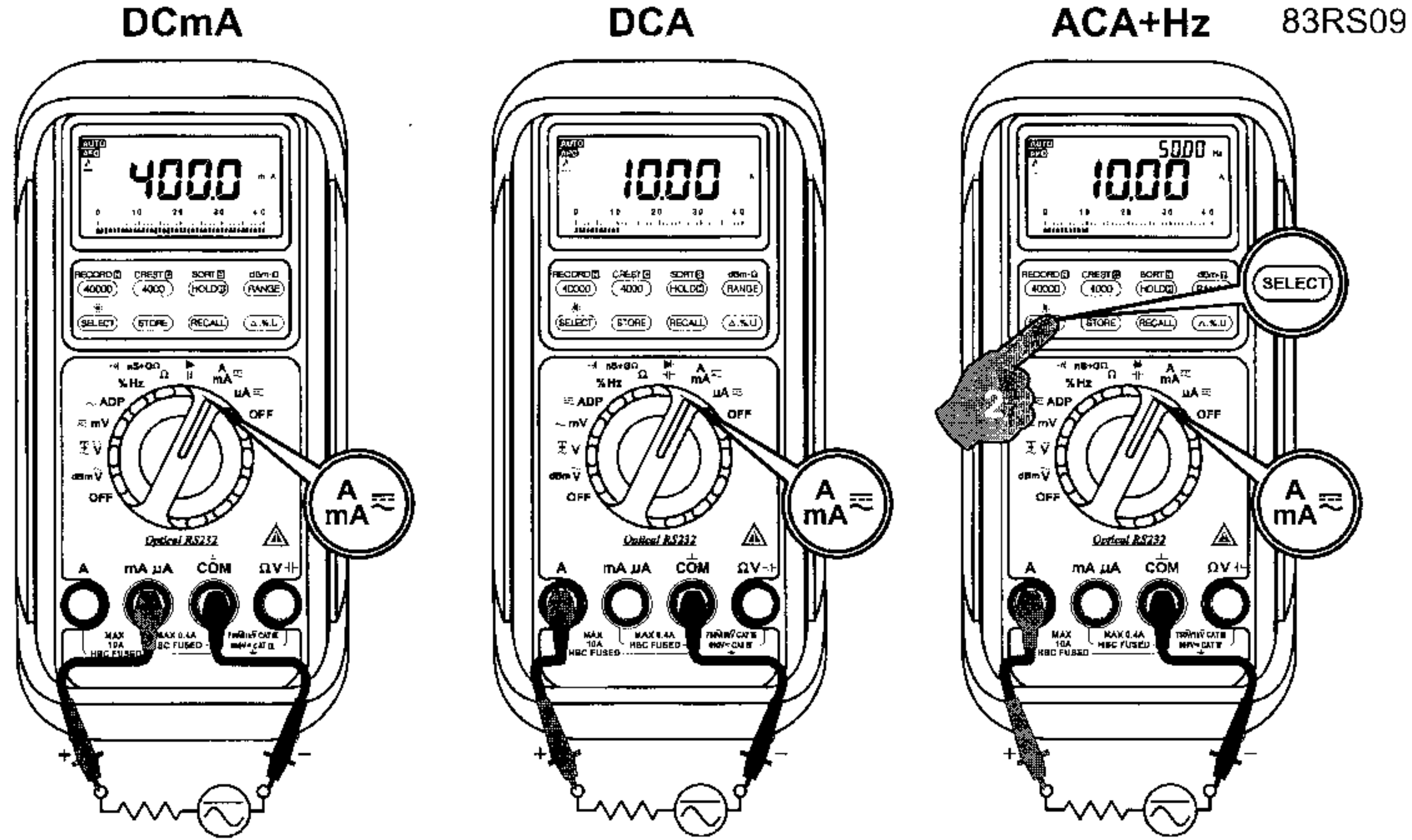

Note:
When measuring a 3-phase system, special attention should be taken to the phase to phase voltage which is significantly higher than the phase to earth voltage. To avoid exceeding the voltage rating of the protection fuse(s) accidentally, always consider the phase to phase voltage as the working voltage for the protection fuse(s).

RS232C PC computer interface capabilities

The instrument equips with an optical isolated interface port at the meter back for data communication. PC interface kit (RS232C optical adapter cable + RS232C software floppies) is required to connect the meter to the PC computer. The RS232C Data Recording System software equips with a digital meter, an analog meter, a comparator meter, and a Data Graphical recorder display. Refer to the README file in the interface kit for further details.

40000 counts high resolution slow mode

Press the **40000** button momentarily to enter the 4-3/4 digit high resolution slow mode. The digital display updates 1.25 times per second nominal to give you smooth readings as well as the full accuracy of the meter. Press the **4000** button momentarily to return to the power up default 3-3/4 digit fast mode. The digital display updates 5 times per second nominal to give you the maximum measuring speed of the meter.

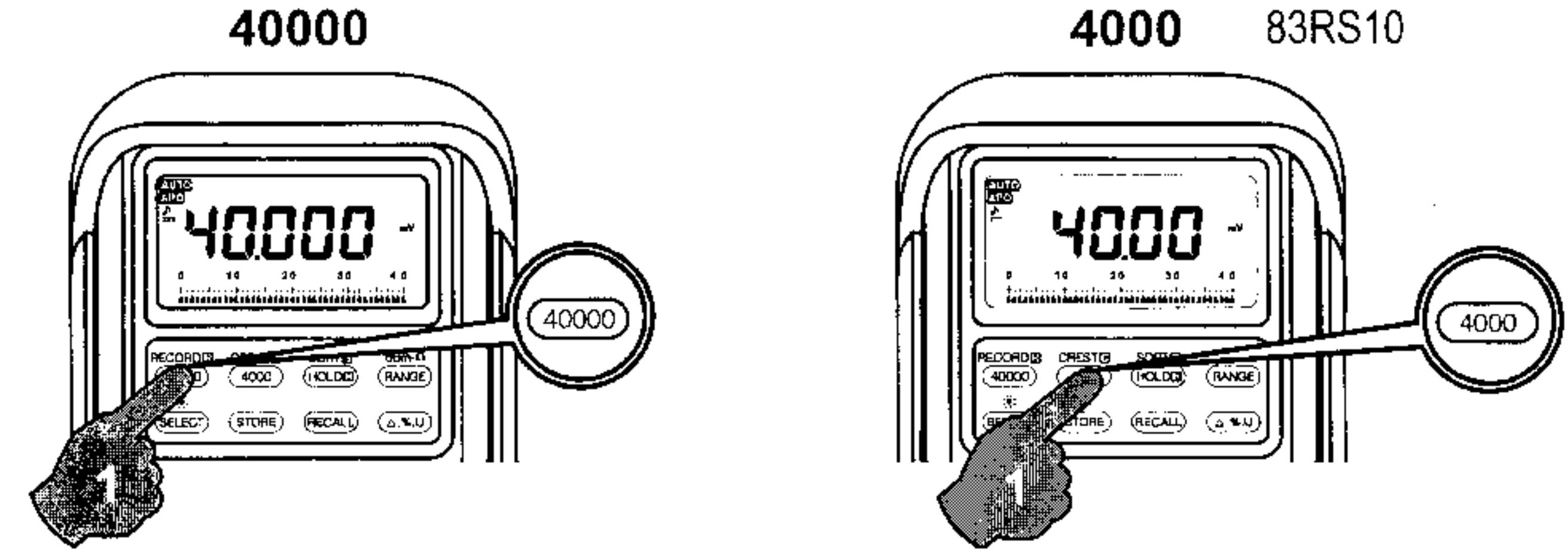

RECORD mode

Press and hold the **RECORD** button for one second or more to activate recording mode with nominal 50ms sampling speed in most functions. The LCD annunciators "R" & "MAX-MIN AVG" turn on. The meter beeps when new maximum or minimum reading is updated. Press the button momentarily to read throughout the Maximum (MAX), Minimum (MIN), Maximum minus Minimum (MAX - MIN), and Average (AVG) readings. Press the button for 1 second or more to exit.

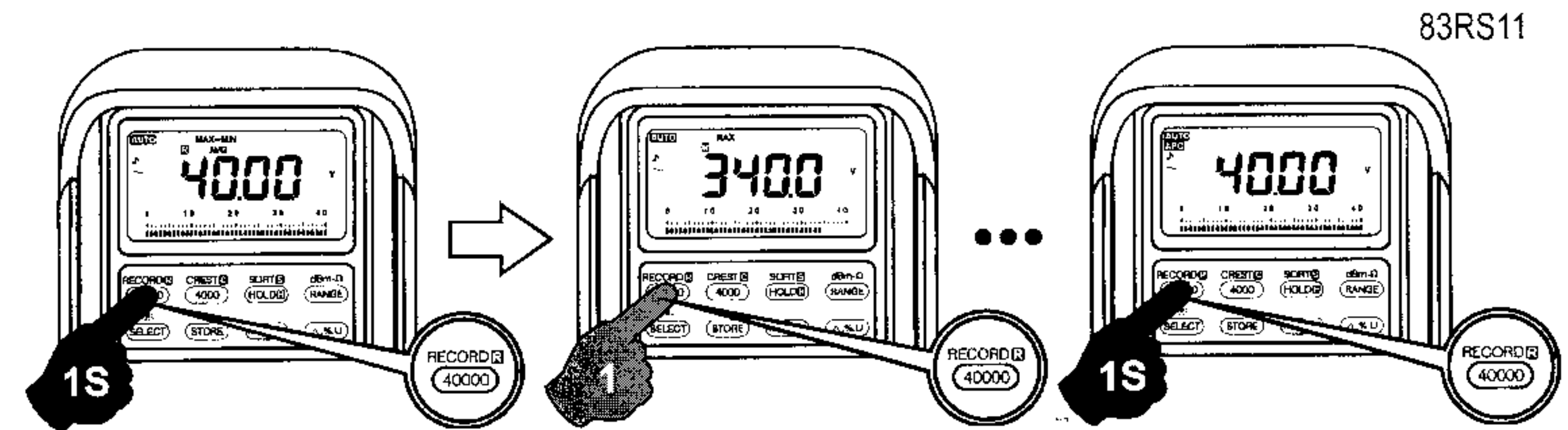

Note:
1. Auto Power Off feature will be disabled automatically in this mode.
2. To retain the readings, press the HOLD button to stop updating the measurement before disconnecting the test leads.

CREST capture mode

Press and hold the **CREST** button for one second or more to activate CREST (Instantaneous peak hold) mode to capture voltage or current signal duration as short as 0.8ms. This mode is available in DCV, ACV, DCA, & ACA functions. The LCD annunciators "C" & "MAX" turn on. The meter beeps when new maximum or minimum reading is updated. Press the button momentarily to read throughout the Maximum (MAX), Minimum (MIN), and Maximum minus Minimum (MAX—MIN) readings. Press the button for 1 second or more to exit CREST capture mode.

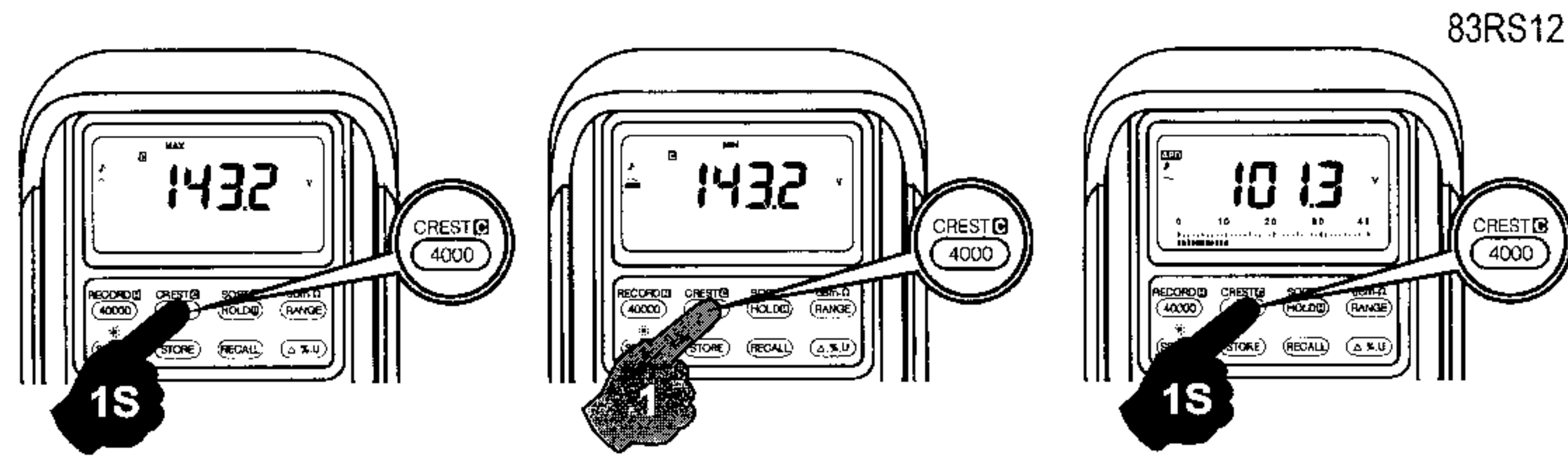

Note:
 1. Auto Power Off feature will be disabled automatically in this mode.
 2. To retain the readings, press the HOLD button to stop updating the measurement before disconnecting the test leads.

Manual or Auto-ranging

Press the **RANGE** button momentarily to select manual-ranging, and the meter will remain in the range it was in, the LCD annunciator **AUTO** turns off. Press the button momentarily again to step through the ranges. Press and hold the button for 1 second or more to resume auto-ranging.

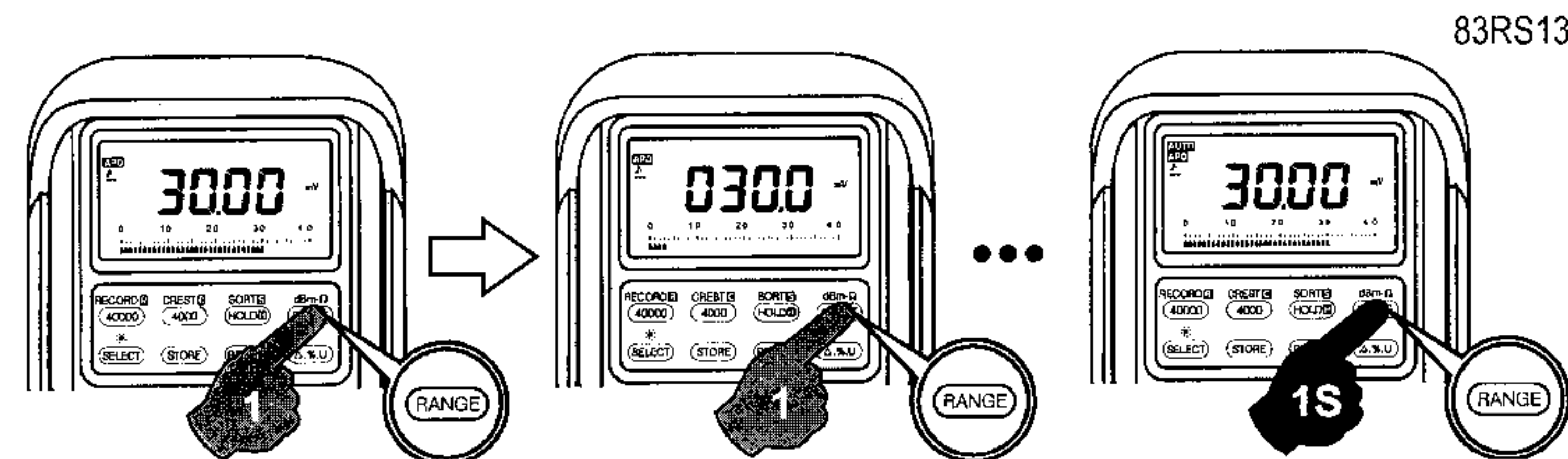

Note: Manual ranging feature is not available in Hz function.

SORT™ mode

Press and hold the **SORT** button for one second or more to activate SORT™ mode. The LCD annunciators "S" & "MAX-MIN AVG" turn on. SORT™ only holds & displays stable measurement, and counts the event number by the secondary display. The meter beeps when new stable reading is captured. Press the button momentarily to read throughout the Maximum (MAX), Minimum (MIN), Maximum minus Minimum (MAX—MIN), and Average (AVG) readings with event numbers out of the captured measurements. Press the button for 1 second or more to exit.

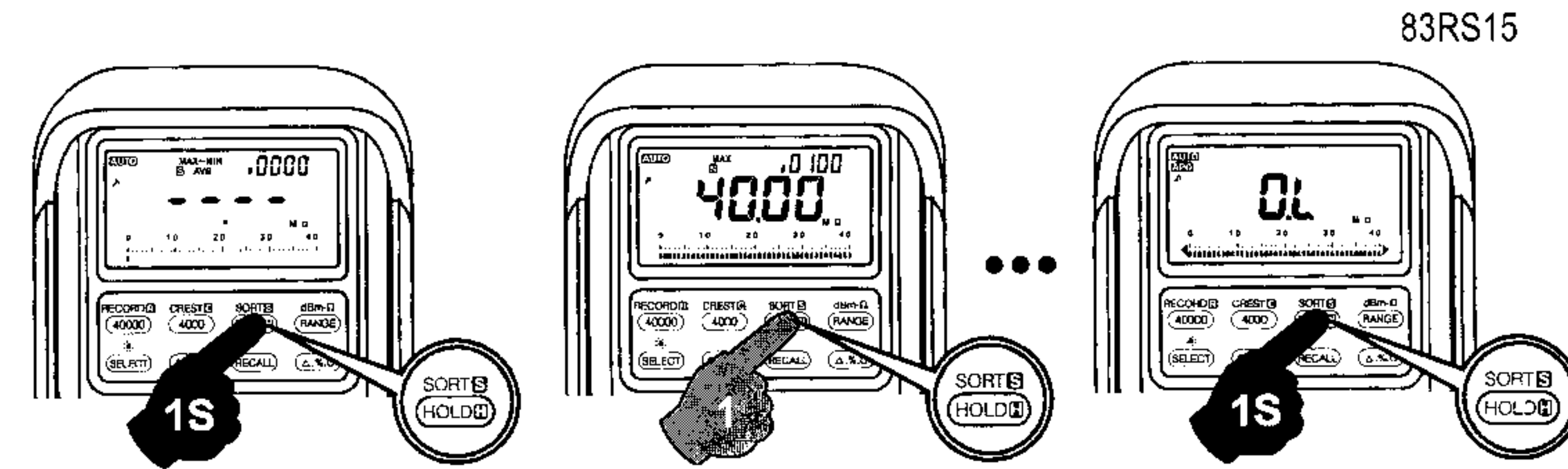

Note:
 1. Auto Power Off feature will be disabled automatically in this mode.

Data Store & Recall

Press the **STORE** button momentarily to store the display for later view. The LCD annunciator MEM will blink two times to confirm storage. The memory will remain even in auto power mode until the rotary switch is switched to the OFF position. Press the **RECALL** button momentarily to recall the stored display in any meter function for quick reference. Press any other button EXCEPT **RECALL** momentarily to resume measurement.

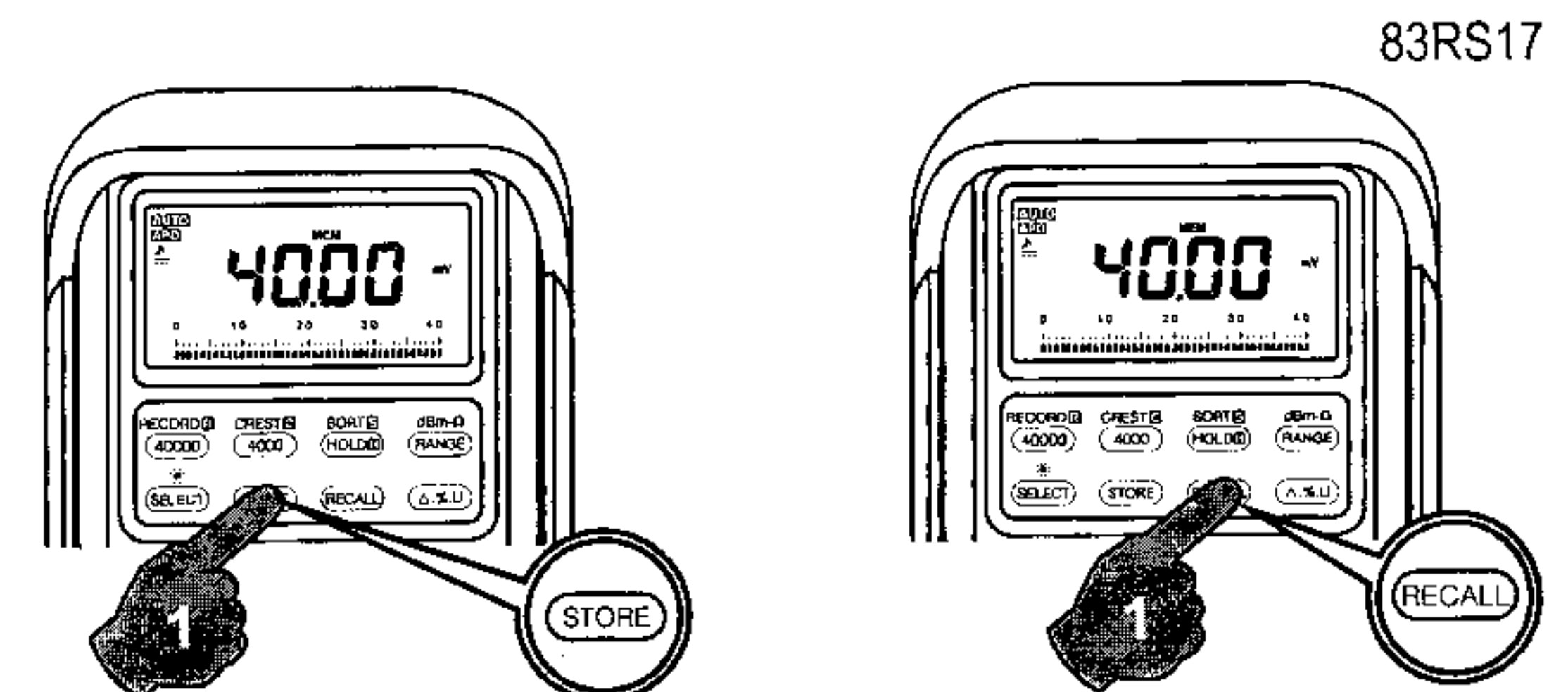

Relative modes

Press the Δ .%.U button momentarily to enter the Relative mode Δ . This allows the meter to set the displaying reading as the reference value and offset (zero) the display. The meter consecutive measurements will then be displayed as the relative reading to the reference value. Practically all displaying readings can be set as the reference value including MAX/MIN/AVG readings of RECORD & SORT features.

Press the Δ .%.U button momentarily again to show the Relative reading in terms of percentage change %. The bar-graph will use the reference value as the center zero point and indicates the + - percentage changes in auto-ranging zoom mode.

Press the Δ .%.U button momentarily again to show the Relative reading in terms of per unit U. The reference value is considered to be one base unit. The meter consecutive measurements will then be displayed as the ratio to the base unit.

Press and hold the Δ .%.U button for one second or more to exit.

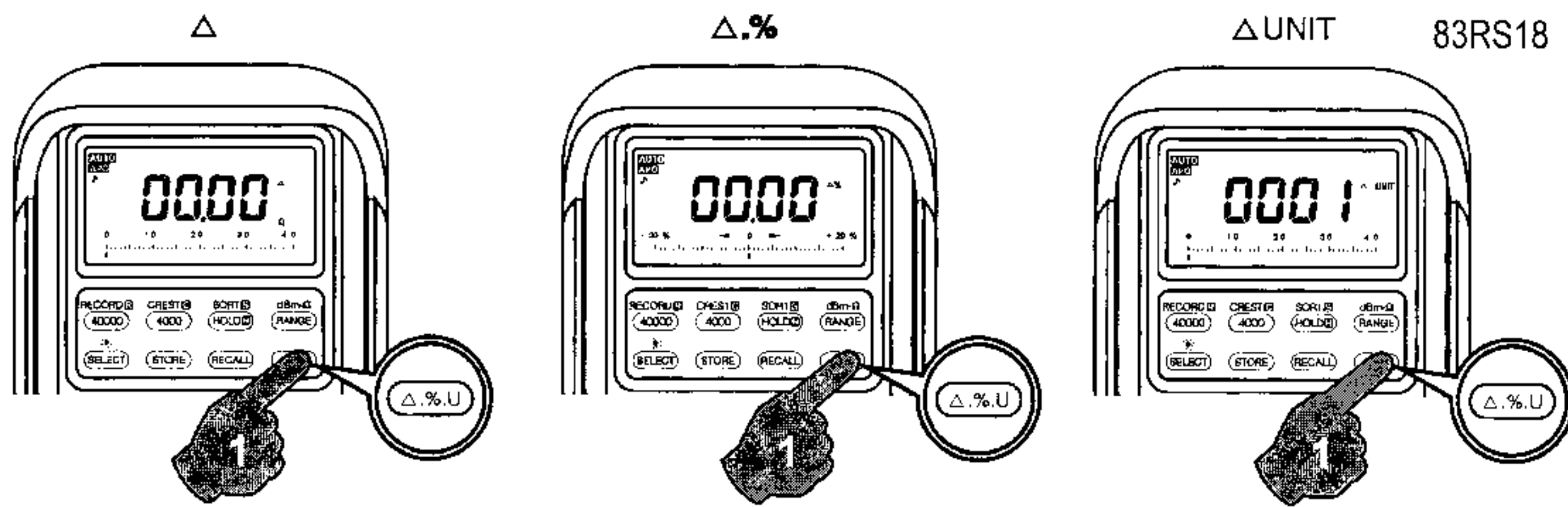

Auto Power Off (APO)

The Auto Power Off (APO) mode turns the meter off automatically to extend battery life after approximately 4.5 minutes of no activities. Activities are specified as: 1) Rotary switch or push button operations, and 2) Significant measuring data readings of above 10% of range. That is, the meter will intelligently avoid entering the APO mode when it is under normal measurements. To wake up the meter from APO, turn the rotary switch to an adjacent position.

Note:

1. Always turn the rotary switch to the OFF position when the meter is not in use.
2. For maintenance purpose, press the **RANGE** button while turning the meter on to shorten the APO timing to 5 seconds.

Disabling Auto Power Off

Press the **4000** button while turning the meter on to disable the Auto Power Off (APO) feature.

Input warning

The meter beeps as well as displays "InErr" to warn the user against possible damage to the meter due to improper connections to the μ A, mA, or A input jacks when other function (like voltage function) is selected.

Line filter frequency selection

Press the **40000** button while turning the meter on to display the set frequency. Press the **SELECT** button for 50Hz or press the **STORE** button for 60Hz to cope with your power line frequency. Then press the **RANGE** button to store the selected frequency. Selecting the appropriate line filter frequency can maximize the meter's noise rejection ability.

Set Beeper Off

Press the **SELECT** button while turning the meter on to disable the Beeper feature. This does not disable the input warning beeper.

5) MAINTENANCE

WARNING

To avoid electrical shock, disconnect the meter from any circuit, remove the test leads from the input jacks and turn OFF the meter before opening the case. Do not operate with open case. Install only the same type of fuse or equivalent

Cleaning and Storage

Periodically wipe the case with a damp cloth and mild detergent; do not use abrasives or solvents. If the meter is not to be used for periods of longer than 60 days, remove the battery and store it separately

Trouble Shooting

If the instrument fails to operate, check battery, fuses, leads, etc., and replace as necessary. Double check operating procedure as described in this user's manual

If the instrument voltage-resistance input terminal has subjected to high voltage transient (caused by lightning or switching surge to the system) by accident or abnormal conditions of operation, the series fusible resistors will be blown off (become high impedance) like fuses to protect the user and the instrument. Most measuring functions through this terminal will then be open circuit. The series fusible resistors and

the spark gaps should then be replaced by qualified technician. Refer to the LIMITED WARRANTY section for obtaining warranty or repairing service.

Battery and Fuse replacement

The meter uses a single standard 9V alkaline battery (NEDA1604A, JIS6AM6, IEC6LF22), a 500V/0.63A IR 200kA fast acting F fuse (FS 1) for μ A/mA current input, and a 600V/15A IR 100kA fast acting F fuse (FS 2) for A current input.

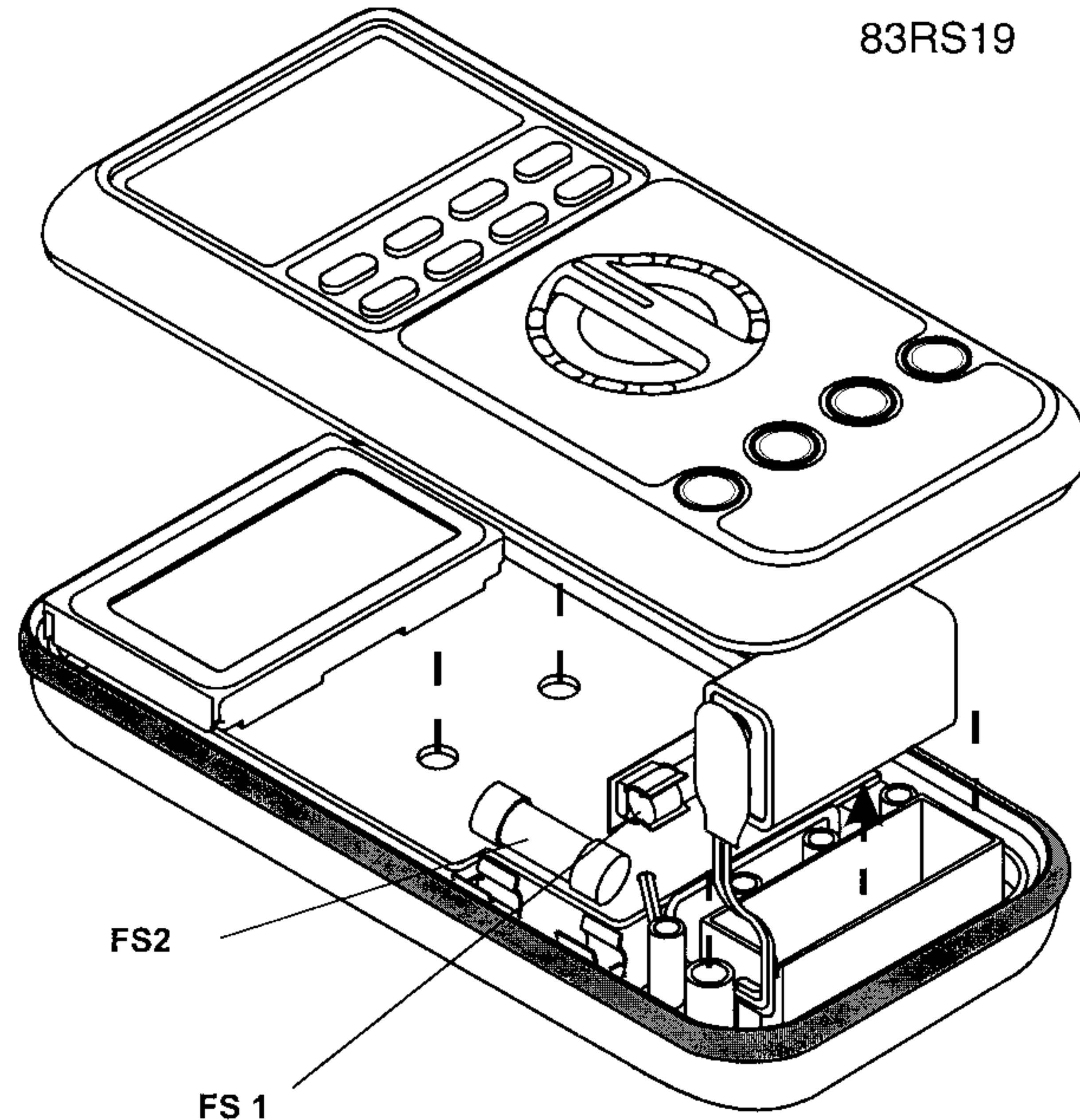

Loosen the screws from the case bottom. Lift the end of the case bottom nearest the input jacks until it unsnaps from the case top. Replace the battery and the blown fuse(s). Replace the case bottom, and ensure that all the gaskets are properly seated and the two snaps on the case top (near the LCD side) are engaged. Re-fasten the screws.

6) SPECIFICATIONS

GENERAL SPECIFICATIONS

Display: 3-3/4 digits 4000 counts or 4-3/4 digits 40000 counts selectable (5 digits 99999 counts for Hz), and 4 digits 9999 counts dual display LCD

Polarity: Automatic

Update Rate:

3-3/4D Data: 5 per second nominal;

4-3/4D Data: 1.25 per second nominal;

43 Segments Bar graph: 128 per second max

Low Battery: The indicator appears when the battery voltage drops below approx. 5.8V

Operating Temperature: 0°C to 50°C

Storage Temperature: -20°C to 60°C, 80% R.H. (with battery removed)

Relative Humidity: 80% (0°C to 35°C), 70% (35°C to 50°C)

Temperature Coefficient: Nominal 0.15 x (specified accuracy)/°C @ (0°C – 18°C or 28°C – 50°C), or otherwise specified

Altitude: Operating below 2000m

Power Supply: Single Alkaline 9V battery NEDA1604A, JIS6AM6 or IEC6LF22

APO Timing: Idle for 4.5 minutes

APO Consumption: 20 μ A typical

Sensing: True RMS conversion

Power Consumption: 12 mA typical

Weight: 390 gm; 500 gm with holster

Dimension: L186mm X W87mm X H35.5mm; L198mm X W97mm X H55mm with holster

Accessories: RS232 adapter cable, RS232 software floppies, Test leads (pair), holster, battery installed, and user's manual

Safety :

The meter meets the requirements for double insulation to IEC61010-1(1995), EN61010-1(1995), UL3111-1(6.1994), CSA C22.2 NO. 1010-1-92 to terminals:

V/R : Category IV 600V ac and dc, and Category III 1000V dc and 750V ac.

μ A/mA : Category III 500V ac, and Category II 300V dc.

A : Category III 600V ac, and Category II 300V dc.

Transient protection : 8kV (1.2/50 μ s surge)

E.M.C. : Meets EN55022(1994/A1; 1995/Class B) and EN50082-1(1992)

In an RF field of 3V/m:

Capacitance function is not specified

Other function ranges: Total Accuracy = Specified Accuracy + 30 digits

Performance above 3V/m is not specified

ELECTRICAL SPECIFICATIONS

Accuracy is ± (% reading digits + number of digits) or otherwise specified, at 23°C ± 5°C & less than 75% R.H. True RMS ACV, (DC+AC)V, & ACA accuracies are specified from 5 % to 100 % of range or otherwise specified. Maximum Crest Factor <3:1 at full scale & <6:1 at half scale, and with frequency component within the specified frequency bandwidth for non-sinusoidal waveforms

DC Voltage

RANGE	Accuracy
40.00 mV	0.5% + 6d
400.0mV, 4.000V, 40.00V, 400.0V, 1000V	0.08% + 1d

NMRR : >60dB @ 50/60Hz

CMRR : >120dB @ DC, 50/60Hz, Rs=1kΩ

Input Impedance : 10MΩ, 30pF nominal
(100pF nominal for 40mV & 400mV ranges)

Temperature coefficient : 0.1 X (Specified accuracy)/°C @(0°C – 18°C or 28°C – 50°C)

Overload protection : 780 Vrms / 1000Vpeak (600 VDC/VAC rms for 40mV & 400mV ranges)

DC Adapter

10 counts per 1 mVDC

Accuracy : 0.08%+1d

Input Impedance : 1000MΩ, 70pF nominal

Temperature coefficient : 0.05 X (Specified accuracy)/°C @(0°C – 18°C or 28°C – 50°C)

Overload protection : 600VDC/VAC rms

(AC + DC) Voltage

RANGE*	Accuracy
50Hz – 60Hz	
4.000V, 40.00V, 400.0V, 750V	0.8% + 8d
40Hz – 1kHz	
4.000V, 40.00V, 400.0V	1.0% + 8d
750V	1.2% + 8d
1kHz – 5kHz	
4.000V, 40.00V, 400.0V	1.2% + 8d
750V	3.2% + 8d**
5kHz – 20kHz	
4.000V, 40.00V, 400.0V	2.0%+8d**
750V	Unspec'd

CMRR : >60dB @ DC to 60Hz, Rs=1kΩ

Input Impedance : 10MΩ, 30pF nominal

*DC Coupled True RMS

**Specified from 10% to 100% of range

Update Rate : 1.6 per second nominal

Overload protection : 780 Vrms / 1000Vpeak

AC Adapter

10 counts per 1 mVAC

Accuracy : Same as AC 400.0mV range

Input Impedance : 1000MΩ, 70pF nominal

Temperature coefficient : 0.1 X (Specified accuracy)/°C @(0°C – 18°C or 28°C – 50°C)

Overload protection : 600VDC/VAC rms

AC Voltage

RANGE*	Accuracy
50Hz – 60Hz	
400.0mV, 4.000V, 40.00V, 400.0V, 750V	0.5% + 3d
40Hz – 1kHz	
400.0mV	0.8% + 3d
4.000V, 40.00V, 400.0V	0.8% + 4d
750V	1.0% + 4d
1kHz – 5kHz	
400.0mV	1.0% + 3d
4.000V, 40.00V, 400.0V	1.0% + 4d
750V	3.0%+6d**
5kHz – 20kHz	
400.0mV	1.5%+6d***
4.000V, 40.00V, 400.0V, 750V	1.8%+6d***
750V	Unspec'd
20kHz – 50kHz	
400.0mV	2.5%+6d****

CMRR : >60dB @ DC to 60Hz, Rs=1kΩ

Input Impedance : 10MΩ, 30pF nominal
(100pF nominal for 400mV range)

*AC Coupled True RMS

**Specified from 10% to 100% of range

***Specified from 15% to 100% of range

****Add (30000/reading) counts below 38% of range

Overload protection : 780 Vrms / 1000Vpeak (600 VDC/VAC rms for 400mV range)

AC Current

RANGE*	Accuracy	burden Voltage
50Hz – 60Hz		
400.0μA	1.0%+4d**	0.15mV/μA
4000μA	0.8%+3d	0.15mV/μA
40.00mA	1.0%+4d**	3.3mV/mA
400.0mA	0.8%+3d	3.3mV/mA
4.000A	1.0%+4d**	0.03V/A
10.00A***	0.8%+3d	0.03V/A
40Hz – 300Hz		
400.0μA	1.5%+4d**	0.15mV/μA
4000μA	1.0%+3d	0.15mV/μA
40.00mA	1.5%+4d**	3.3mV/mA
400.0mA	1.0%+3d	3.3mV/mA
4.000A	1.5%+4d**	0.03V/A
10.00A***	1.0%+3d	0.03V/A
300Hz – 3kHz		
400.0μA	Unspec'd	0.15mV/μA
4000μA	1.2%+3d	0.15mV/μA
40.00mA	Unspec'd	3.3mV/mA
400.0mA	1.2%+3d	3.3mV/mA
4.000A	Unspec'd	0.03V/A
10.00A***	1.2%+3d	0.03V/A

*AC Coupled True RMS

**Specified from 10% to 100% of range

***10A continuous; 20A for 30 seconds maximum, 5 minutes cool down interval

mA μA Overload Protection : 0.63A/500V quick acting fuse, Interrupt Rating 200kA

A Overload Protection : 15A/600V F quick acting fuse, Interrupt Rating 100kA